

Modular Sofa

Assembly Guide

Branch

The new way of working you've been waiting for.

Scan here for a digital copy
of your assembly guide.





Caution

- Make sure to read the guide completely before assembling.
- Do not use this sofa as a step stool/ladder, or on uneven floor surfaces.
- Do not sit on any part of the sofa except the seat cushions.
- Do not use sofa unless all bolts, screws, and knobs are tightened.
- Every six months, please make sure all bolts, screws, and knobs are fully tightened to ensure stability.
- If any parts are missing, broken, damaged, or worn, stop use of the product until repairs are made using Branch authorized parts.
- Failure to follow these warnings could result in serious injury.

Components

Corner

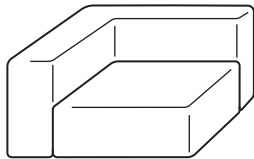

Center

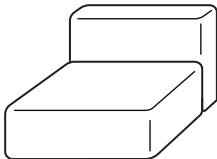

Left

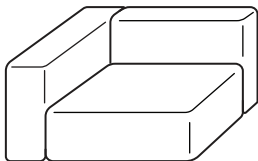

Right

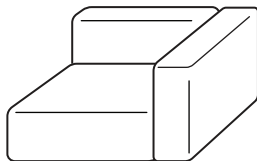

Included Hardware



Connection Joint
x2 per module
(preinstalled)

1

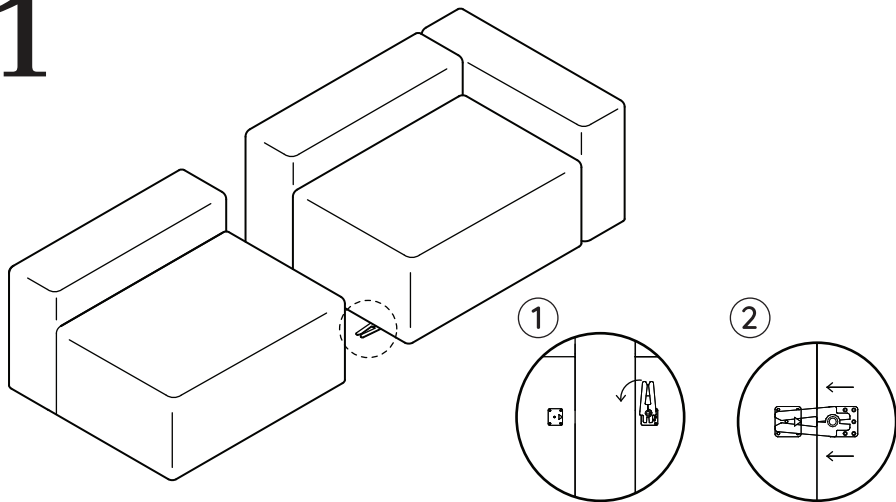

Use the **Connection Joints** (x2 per module) to attach two **Sofa Modules** together. Repeat as many times as needed for the desired configuration on remaining modules

Common Configurations

Components:

Corner



Center



Left



Right



Modules:

Use a combination of modules to create seating to fit any space

Sofa 126:

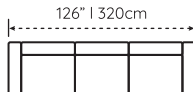

Modules:

Left (x1), Center (x1), & Right (x1)

Sofa 90:

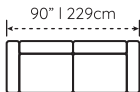

Modules:

Left (x1) & Right (x1)

Corner Sectional 116:

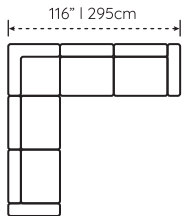

Modules:

Left (x1), Center (x2), Corner (x1), & Right (x1)

Contact

Have a question, comment, or suggestion?

hello@branchfurniture.com
branchfurniture.com

Branch